

landscapeforms



# STRATA Beam Bench

## A Flexible Family Creates Unique Site Identity

STRATA Beam, designed by Jess Sorel, marries Landscape Forms' proprietary Glass Fiber Reinforced Concrete (GFRC) with the warmth of wood in benches that create distinctive gathering and resting places in natural and urban settings. STRATA Beam benches can be joined together in myriad arrangements using the STRATA Beam expansion modular connectors, enabling designers to arrive at aesthetics uniquely their own.







## Designed to Be One-of-a-Kind

With modular bridge legs and three different angle connectors in 90°, 60° and 45°, the STRATA Beam expansion widens the scope of the STRATA Beam family. Customized configurations range from familiar L-benches and U-benches, to fully enclosed squares, hexagons and octagons, to snaking asymmetric runs and mixed configurations incorporating singular STRATA Beam benches.

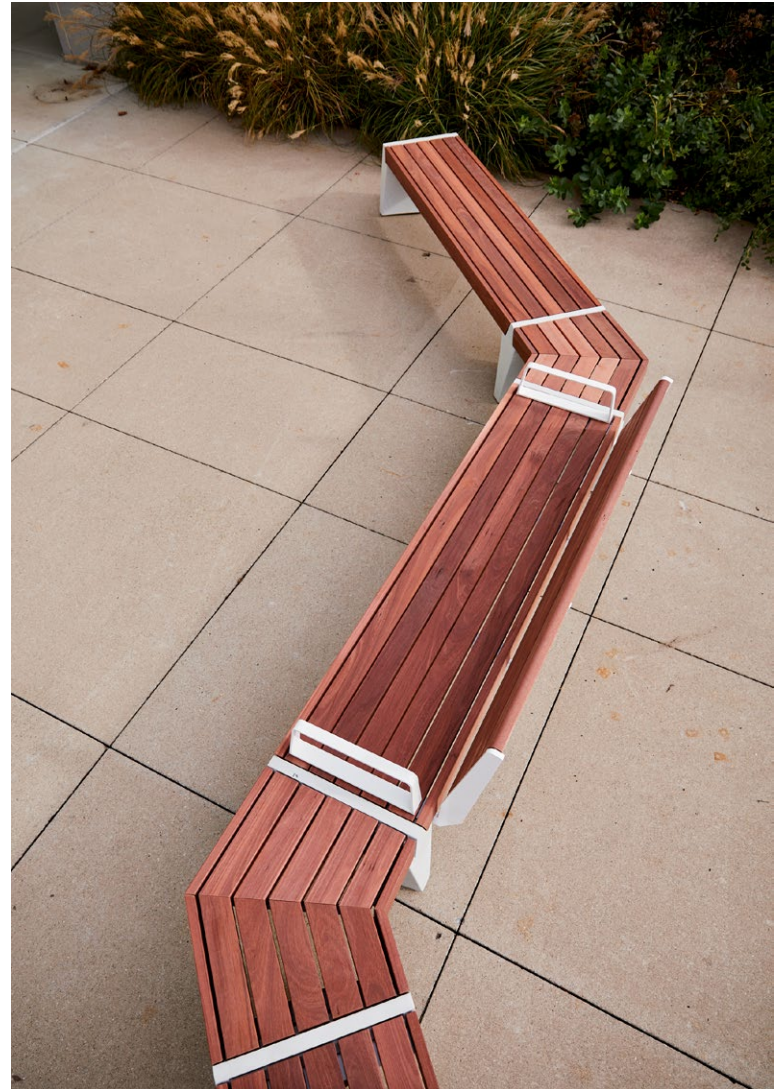

## Architectural Presence that Creates a Sense of Place

Cast concrete structural elements spanned by wood seat surfaces provide contrasts between cast and milled, hard and soft, and cool and warm. The thin profile and sculptural form of the GFRP structure belie its durability, while light plays quietly across the faceted concrete surfaces and through the slatted wood.







## **Striking Family Characteristics**

The STRATA Beam family includes benches in 31" and 69" lengths and an 80"-long, three-seat bench with and without a back and optional arms. STRATA Beam's Glass Fiber Reinforced Concrete (GFRC) components are offered in a white, natural and deep gray.











# Materials

## Vivid Series - Powdercoated Metal (Fine Texture)



Clay

Lemon

Mango

Chili

Loll Apple Red

Loll Leaf Green



Moss

Forest

Loll Navy Blue

---

## Neutral Series - Powdercoated Metal



Silver Metallic

Mercury Metallic

Steel Metallic

Bronze Metallic

Titanium Metallic



Gloss Black

Gloss White

---

## Architectural Series - Powdercoated Metal (Fine Texture)



Fog

Obsidian

Matte Black

Terra

Nutmeg

Onyx



Sage

Blue Ash

Dusk

# Materials (cont.)

## Glass Fiber Reinforced Concrete (GFRC)

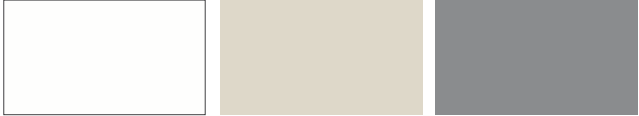

Natural White

Natural Ecrú

Natural Grey

---

## Woodgrains (Exterior, No Finish)



Domestically Sourced  
Thermally Modified Ash

Ipe (P)

Jarrah (P)

---

## Woodgrains (Interior, LF-80 Finish)



Domestically Sourced  
Thermally Modified Ash

Jarrah (P)

Statement of Line

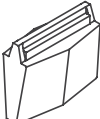
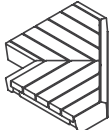
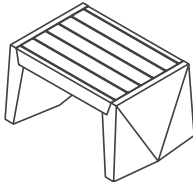
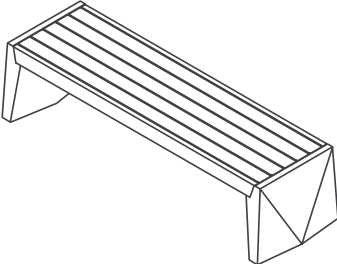
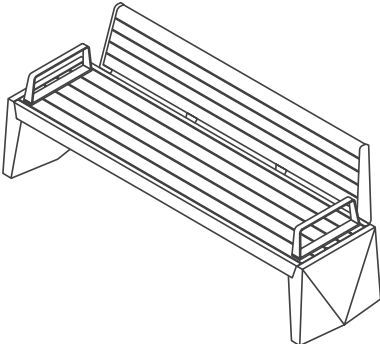



landscapeforms

# STRATA Beam