

Profile Area

Specification Sheet | BW400



The Profile family of light columns brings together a variety of illumination techniques within a sleek and minimalist column design. Profile's 'I-Beam' shape is recognizable as an architectural element, introducing crisp lines between light and shade on the surface of the column and a three dimensionality rarely seen outdoors.

Profile Area offers a range of performance output and distribution options, alongside visual interest and wayfinding features. Optional, decorative grazing light engines highlight the iconic 'I-beam' form, whilst the 'footlights' ground the column at pedestrian scale.

Housing & Materials

Cast and extruded aluminum construction. Luminaire elements consist of a die cast and machined aluminum housing and sealed, UV stable, impact modified acrylic lens. All hardware is magni-coated for optimum corrosion and 'anti-seize' protection. Assembly is IP66 rated.

Electrical

Surge protected 120V - 277V 50/60Hz electronic driver, 0-10V dimming, -40°C start temperature. Cast aluminum driver compartment doors with weather-tight seal assembly located at bottom of pole. Available with optional ANSI C136.41 twist lock receptacle.

Light Engine

The Profile area light includes a performance luminaire(s) and optional grazing and footlighting options. The performance luminaire features sealed, field replaceable LED cartridge with die-cast aluminum heatsink, high power LEDs on a RoHS compliant circuit board, and secondary optics. The optional grazing and footlighting elements also feature a replaceable LED cartridge, high power LEDs on a RoHS compliant circuit board and secondary optics. All light engines are available in 2700K, 3000K, 3500K, and 4000K. >80CRI across all available color temperatures. All luminaire elements meet or exceed TM21 L70: >60,000 hrs.

Distributions

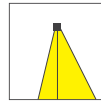

TII

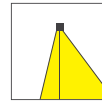

TIII

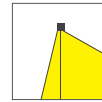

TIV

Warranty

LED lighting products are warranted for six years.

Certification

UL Listed for Wet Location, CE, International Dark Sky Approved, Buy America Compliant, RoHS Compliant, cUL



Designed by Linnaea Tillett & Tillett Lighting Design Associates

[Click here](#) for patent information related to this product.

Profile Area

landscapeforms

Specification Sheet | BW400

Specification

Luminaire

Luminaire and Column (Complete)

Luminaire Series	Overall Height	Area Luminaire Arrangement	Foot Light	Distribution	Drive Current	Lens	Color Temperature**	Input Voltage	Twist Lock
BW401 (Single Section Column - No decorative grazer elements)	10 (10 ft or 3.1m Unit) *			T2 (Type II)	LO (Low Output)	CLR (Clear Lens)	27K (2700K)		
BW402 (Triple Section Column - two decorative grazer elements)	12 (12 ft or 3.7m Unit)	A (Single)	NFL (No Foot Light)	T3 (Type III)	HO (High Output)	FRS (Frosted Lens)	30K (3000K)	UV1 (100V277V, 50/60 Hz)	NTW (No Twist Lock)
	14 (14 ft or 4.3m Unit)	B (Back to Back)	FL (Foot Light)	T4 (Type IV)			35K (3500K)		TW1 (7-pin Twist Lock)
BW403 (Triple Section Column - Four decorative grazer elements)	16 (16 ft or 4.9m Unit)						40K (4000K)		

Example: BW401 – 10 – B – NFL – T2 – LO – CLR – 35K – UV1 – TW1 – Powdercoat

* Only available in BW401.

** For Dark Sky certification, 3000k or warmer must be selected. Other color temperatures available upon request.

Modifications

Part Number	Modification	Description
CAM	Camera	
SPE	Speaker	
WAP	WiFi Access Point	
BAN	Banner Arms	
CPH	Custom Pole Height	
CLH	Custom Lens Height	
CPC	Custom Powdercoat Color	
--	Other	

Modifications listed are the most common changes/additions requested. If your requirements aren't shown here, select 'other' and write in the modification needed. Please provide as much detail as possible to streamline the quoting process. All modifications to standard products will require evaluation and quoting approved by Landscape Forms prior to order placement.

Profile Area

landscapeforms

Specification Sheet | BW400

BW400 Series Dimensions

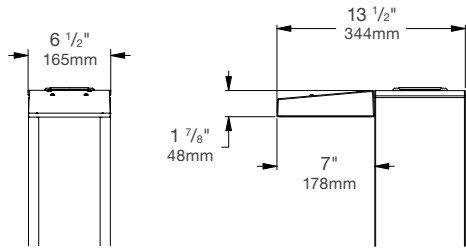

Area light - single

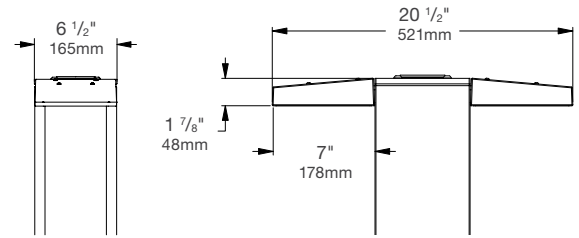

Area light - back to back

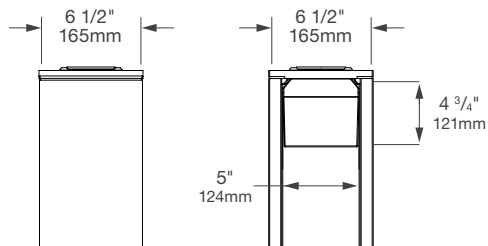

Grazer (featured on BW402 and BW403 only)

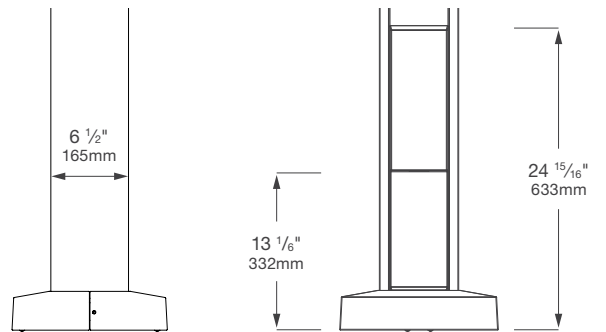

Foot light (optional)

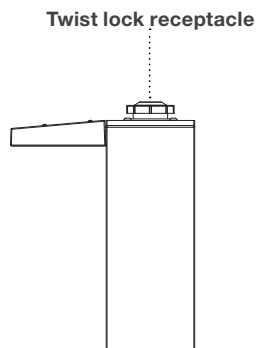

Twist lock receptacle

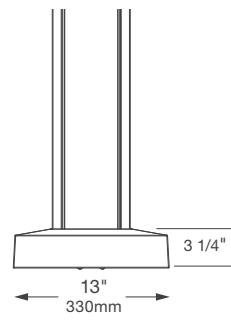

Base Cover

Profile Area

Specification Sheet | BW400

Luminaire Configuration Selection Guide - BW401 Series

The BW401 Series is the simplest configuration, available with either single or back to back area distribution luminaires (ordering code 'A' or 'B' respectively). Footlight is an option for all variations.

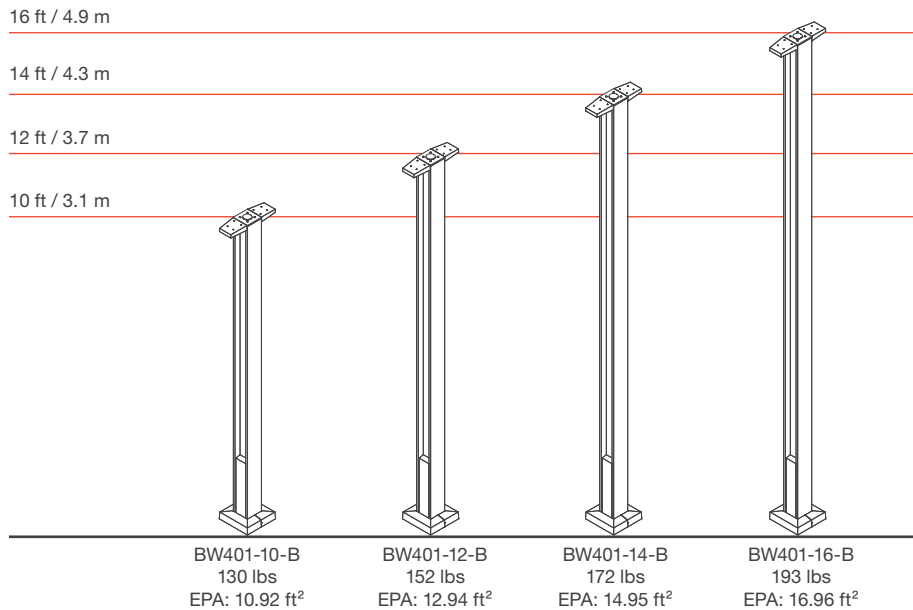
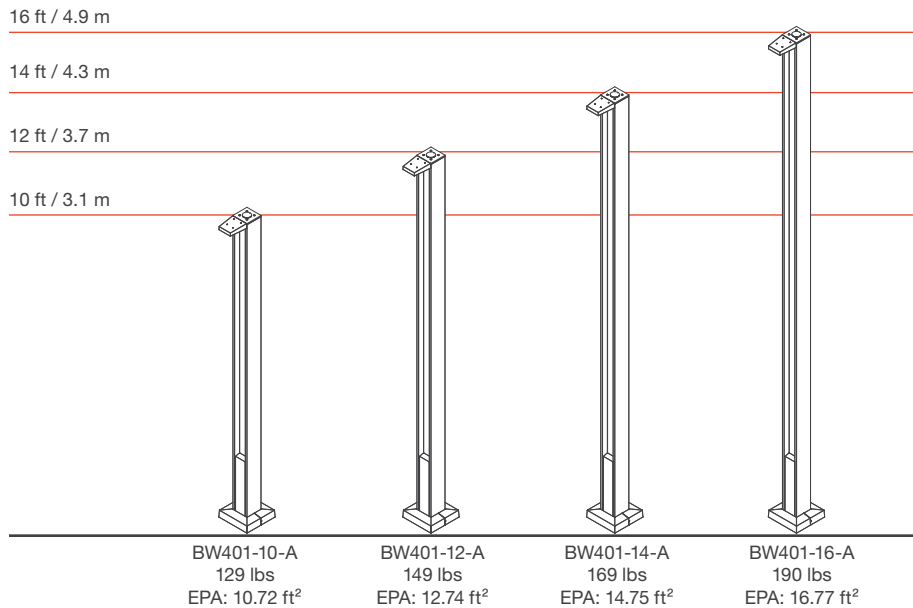

Profile Area

Specification Sheet | BW400

Luminaire Configuration Selection Guide - BW402 Series

The BW402 Series features two inset graze lighting elements back to back, and within the 90° turned section of the pole. This series is available with either single or back to back area distribution luminaires (ordering code 'A' or 'B' respectively). Footlight is an option for all variations.

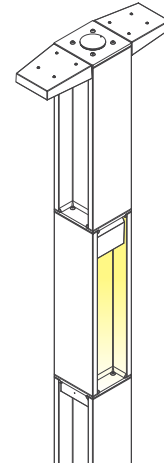
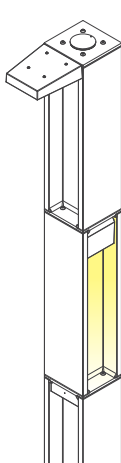
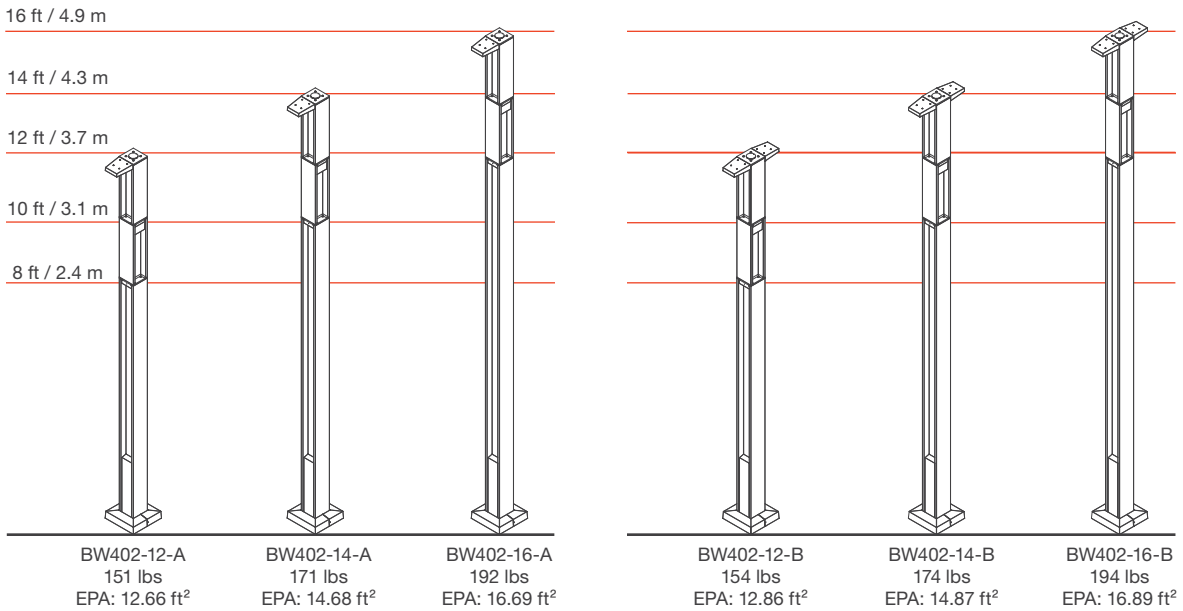

Profile Area



Specification Sheet | BW400

Luminaire Configuration Selection Guide - BW403 Series

The BW403 Series features four inset graze lighting elements, with each pair back to back; two within the 90° turned section of the pole, and two within the lower, open section of the channel. This series is available with either single or back to back area distribution luminaries (ordering code 'A' or 'B' respectively). Footlight is an option for all variations.

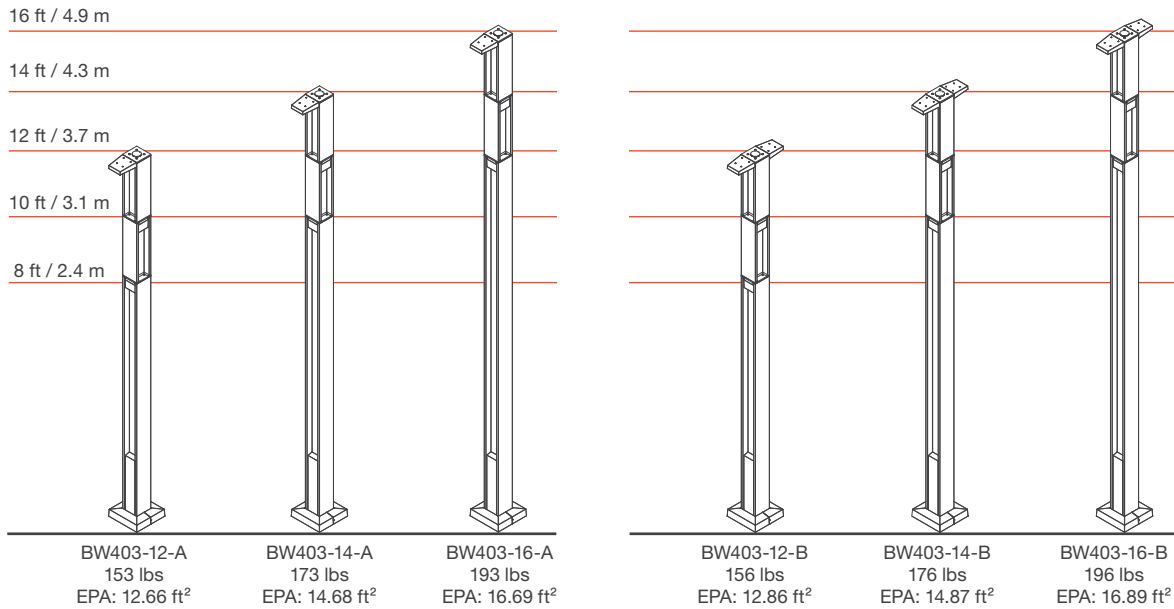

Profile Area

landscapeforms

Specification Sheet | BW400

Area Luminaire Performance Data

3500K data shown

Drive Current	Lens	Distribution Type	Delivered Lumens	System Watts	BUG Rating
LO	CLR	T2	2700	27	B1-U0-G1
		T3	2599	27	B1-U0-G1
		T4	2414	27	B1-U0-G1
	FRS	T2	2261	27	B1-U0-G1
		T3	2170	27	B1-U0-G1
		T4	1971	27	B1-U0-G1
HO	CLR	T2	4450	52	B1-U0-G1
		T3	4391	52	B1-U0-G1
		T4	4488	52	B1-U0-G1
	FRS	T2	3711	52	B1-U0-G1
		T3	3631	52	B1-U0-G1
		T4	3302	52	B1-U0-G1

Lumen output scaling factors: 2700K (0.9), 3000K (0.96), 4000K (1.007)

Optional Elements

3500K data shown

Element	Lens	Distribution Type	Delivered Lumens	System Watts	BUG Rating
Graze	Clear	N/A	136	10	B0-U1-G0
Footlight	Frosted	N/A	15	4	B0-U1-G0

Lumen output scaling factors: 2700K (0.9), 3000K (0.96), 4000K (1.007)

Profile Area

Specification Sheet | BW400

400 Series – Frosted Lens LO at 10'

Performance light engine @ 3500K

1.0fc 0.5fc 0.2fc

10' Lens Height, Low Output, Frosted Lens, Type II

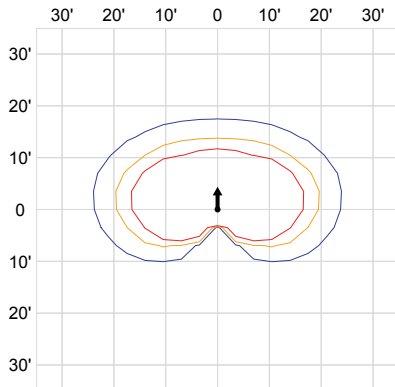

10' Lens Height, Low Output, Frosted Lens, Type III

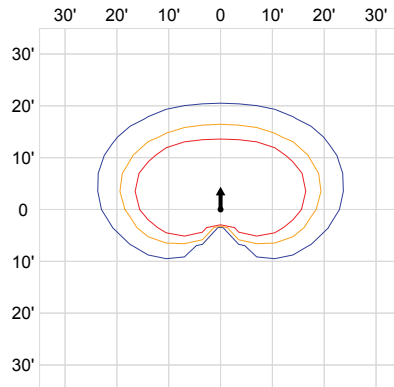

10' Lens Height, Low Output, Frosted Lens, Type IV

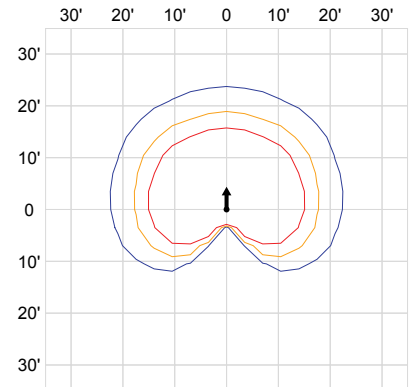

400 Series – Frosted Lens HO at 12'

Performance light engine @ 3500K

1.0fc 0.5fc 0.2fc

12' Lens Height, High Output, Frosted Lens, Type II

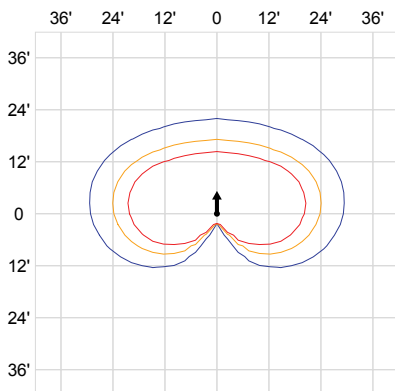

12' Lens Height, High Output, Frosted Lens, Type III

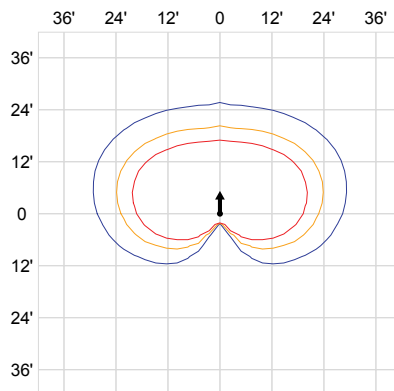

12' Lens Height, High Output, Frosted Lens, Type IV

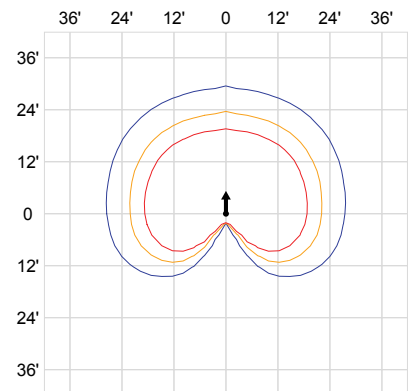

Profile Area

Specification Sheet | BW400

400 Series – Clear Lens LO at 14'

Performance light engine @ 3500K

■ 1.0fc ■ 0.5fc ■ 0.2fc

14' Lens Height, Low Output, Clear Lens, Type II

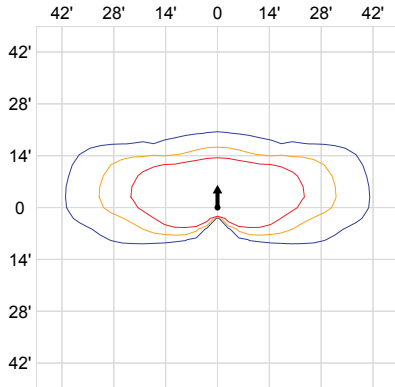

14' Lens Height, Low Output, Clear Lens, Type III

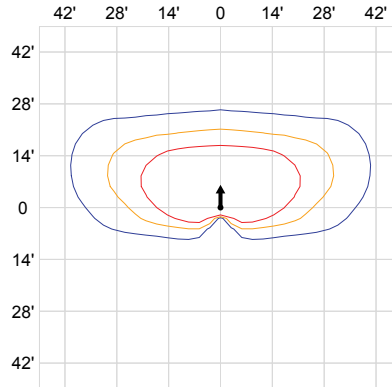

14' Lens Height, Low Output, Clear Lens, Type IV

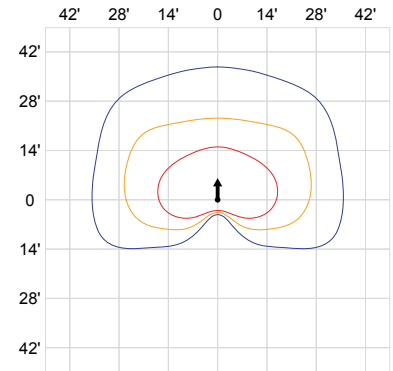

400 Series – Clear Lens HO at 16'

Performance light engine @ 3500K

■ 1.0fc ■ 0.5fc ■ 0.2fc

16' Lens Height, High Output, Clear Lens, Type II

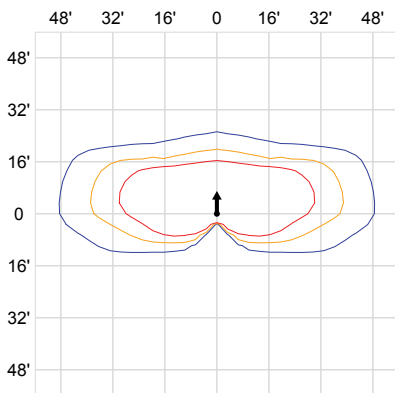

16' Lens Height, High Output, Clear Lens, Type III

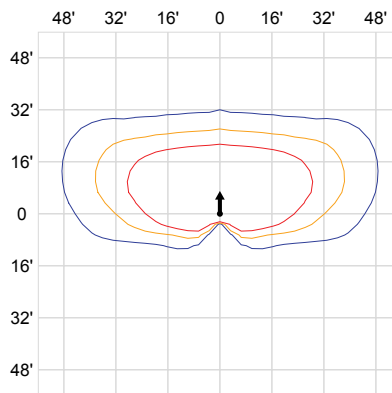

16' Lens Height, High Output, Clear Lens, Type IV

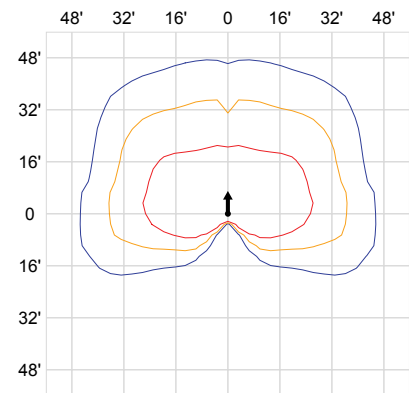

Profile Area

landscapeforms

Specification Sheet | BW400

Architectural Series - Powdercoated Metal* (Fine Texture)

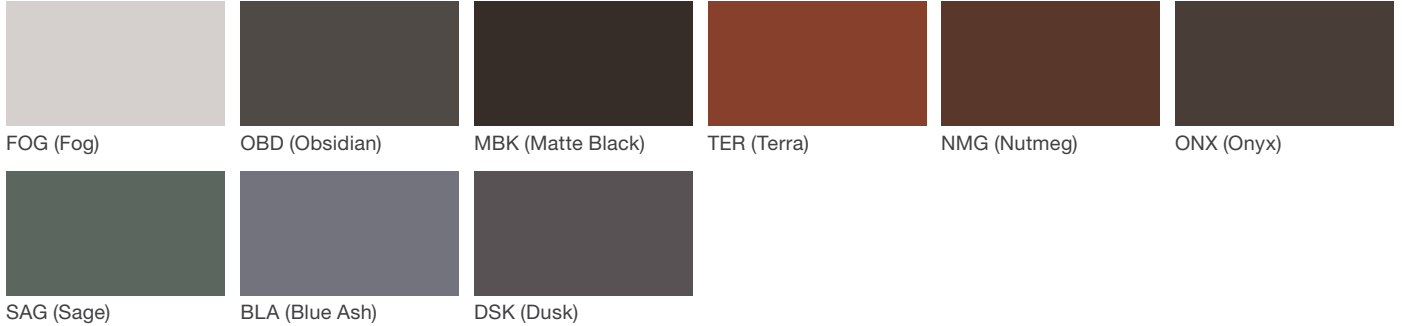

Neutral Series - Powdercoated Metal*

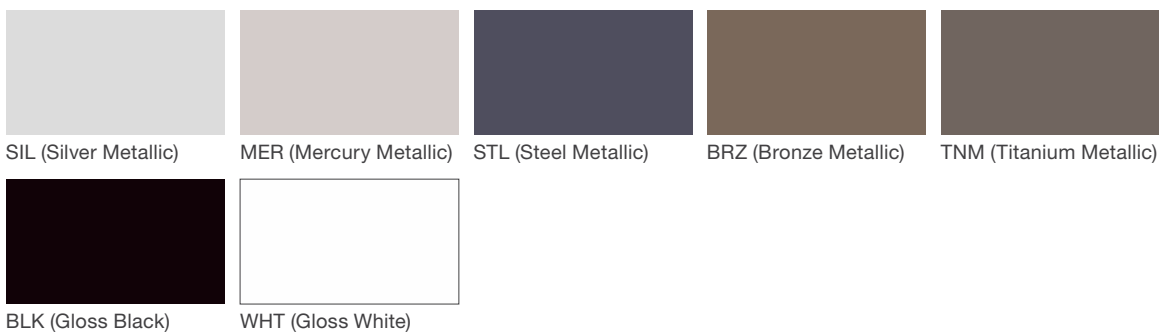

Vivid Series - Powdercoated Metal* (Fine Texture)



Profile Area

landscapeforms

Specification Sheet | BW400

Powdercoated Metal

Powdercoated Metal Pangard II® Polyester Powdercoat is a hard, yet flexible, finish that resists rusting, chipping, peeling and fading. In addition to colors shown, a wide selection of optional and custom colors may be specified for an upcharge.

* All colors and patterns shown are approximate and may vary from sample and final.

Visit landscapeforms.com for more information.

Specifications are subject to change without notice.

©2024 Landscape Forms, Inc. Printed in U.S.A.

landscapeforms.com | specify@landscapeforms.com