

PLEXUS

Product Data Sheet



There's a reason some things endure. Like Plexus, they simply get it right. This Roscoe award-winning design expresses the happy orchestration of form, function and material invention. Plexus wrote the vocabulary for wire grid in outdoor seating and captured the imagination of designers in the process.

Seat

- Plexus wire grid panel is constructed of 5/16" perimeter and reinforcement wires (on 2-1/2" centers), with 1/8" cross wires on 1/2" centers.
- Wire grid is welded into a frame formed of tubular steel that is 7/8" o.d., and has .120" wall thickness.
- Arms are constructed of tubular steel 7/8" o.d., .120" wall thickness.
- Tables have the same basic wire grid panel and are offset to align with front of backed seat.
- Receptacles are constructed with 7/8" diameter tubular steel rings at top and bottom of the grid panels.
- Litter receptacle lids are formed of spun metal, liners of polyethylene.
- Ash urn interior panels are formed of fiberglass.
- Hardware for seats, tables, arms and horizontal tube sections is shipped with each order.
- Glides for freestanding supports are included.
- Hardware for anchoring supports is NOT included.
- Surface and wall mounted supports are drilled to accept up to 1/2" anchor bolt of non-corrosive material.

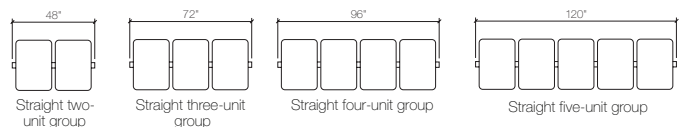

Suggested Groupings

- Basic groups can be arranged in nearly unlimited configurations.
- A few examples are shown on this page.
- Seats (with or without back) and tables may be interchanged in any combination in most of these examples.

PLEXUS

Product Data Sheet

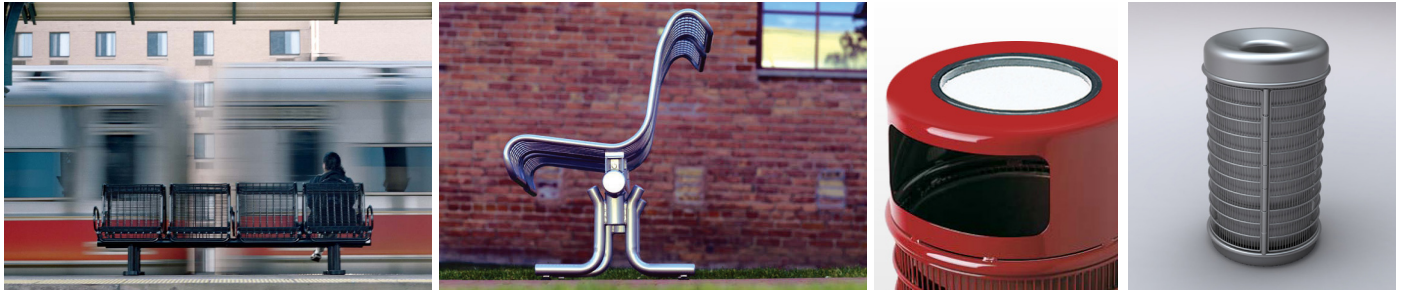

Horizontal Tube

- A 3" o.d. horizontal tube forms the spine of the Plexus Collection.
- Seats and tables have welded adapters which mate with adapters on the horizontal tube.
- This creates an opportunity for the designer to specify seats and tables in a variety of configurations.
- Straight tubes come in standard lengths of 24" for single seat (may not be freestanding), 48" for two seats, 72" for three seats, 96" for four seats, and 120" for five seats.
- Curved tubes are available in two-, three-, four- and five-seat units (curved two seat unit may not be freestanding; curved five-seat unit may not be wall mounted). Seat and table units are spaced 24" o.c., allowing 2" between each unit.
- There are two supports for each standard run of seats, straight or curved.
- A third support is added in the center of all curved freestanding units.
- The horizontal tube and supports will be the same color as the seats and tables.
- All fastenings for assembling the units and attaching the arms are included.
- Hardware for mounting supports to the floor or walls is NOT provided.

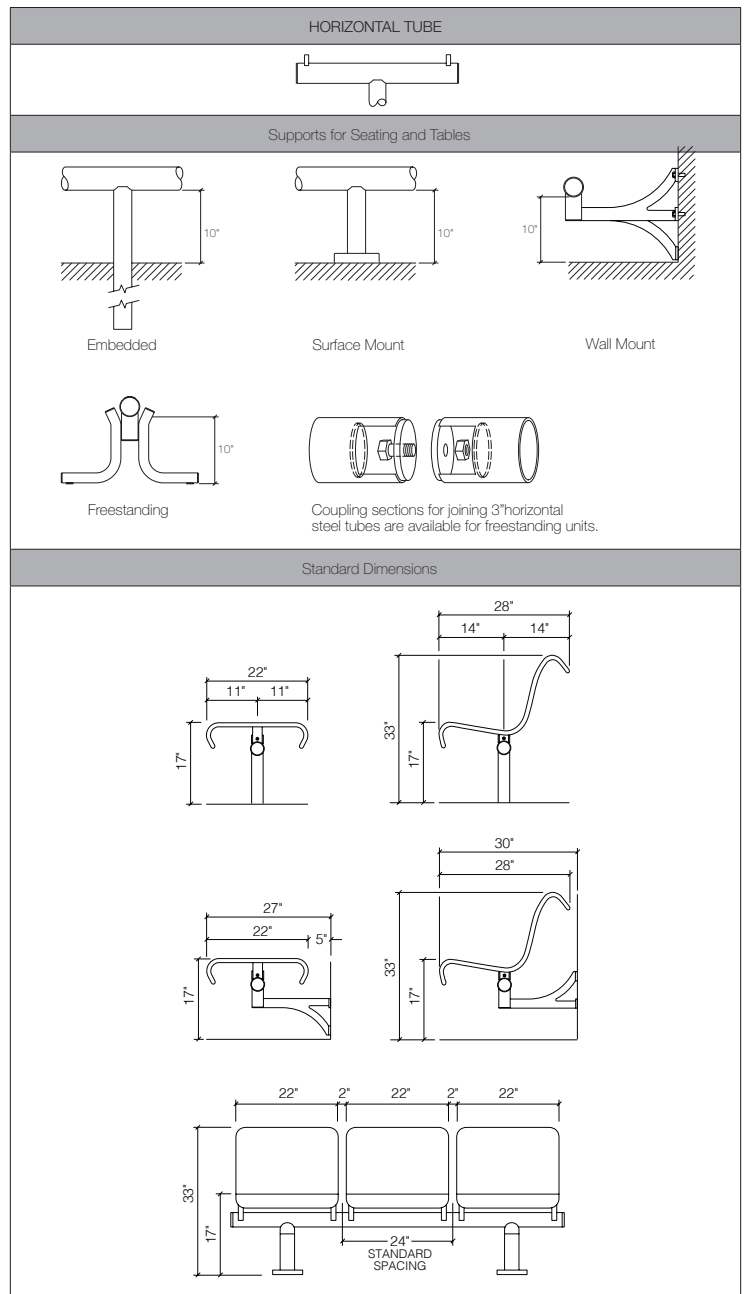

PLEXUS

Product Data Sheet



Support Options

Embedded Support

- 2-1/2" o.d. steel tube for embedding in concrete.
- Tube is 29" long.

Surface mount Support







- 2-1/2" o.d. steel tube with round 5/16" x 5-1/2" diameter floor flange.
- Bolts for attaching unit to surface are not included.
- Cover plate is 1-1/2" high x 6" diameter.

Freestanding Support

- 1-1/2" o.d. tube supports. Adjustable glides are included.
- Optional anchor tabs available for permanent installations.
- Bolts for attaching unit to surface are not included.

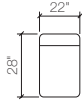
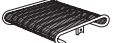
Wall mount Support

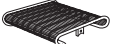
- 3/8" thick steel support with standard coupling welded to 3/8" x 3" steel wall plates.
- Bolts for attaching unit to wall are not included. (Mounting bracket slopes down when used with backless seats.)
- Not recommended for curved installations.

COMPONENT	STRAIGHT RUN
  Backed Seats <p>Optional arm rests are available for all seats with backs and can fit between seats or at the end of a run of seats. Constructed of 7/8" diameter tubular steel.</p> <p>Specify number and location of arms needed per run.</p>	 22" x 28" Straight seat with back for straight run applications.
  Backless Seats	 22" x 22" Square flat seat or table
 Companion Tables for Backed Seats	 22" x 22" For use with straight seat with back



PLEXUS

Product Data Sheet

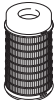

Litter Receptacles

- Feature a powdercoated metal grid body with a hinged door that opens to the side, allowing the liner to slide out for emptying.
- A metal latch secures the door when the unit is in use.
- Offered in 16" size (15 gallon capacity) and 20" size (30 gallon capacity).
- Either size may be specified side or top opening.
- Both receptacles are standard with freestanding/surface mount capability.
- The lid is formed of spun metal and the coordinating polyethylene liner matches the standard powdercoat color selected for receptacle.
- Ash pan insert is offered for side opening receptacles.

	STYLE	DIAMETER	HEIGHT	PRODUCT WEIGHT
	top opening: freestanding / surface mount only	20"	36"	75 lb
	side opening: freestanding / surface mount only	20"	40"	73 lb

Finishes

- All metal is finished with Landscape Forms' exclusive Pangard II® polyester powdercoat — a hard, yet flexible finishing process that resists rusting, chipping, peeling and fading.

To Specify Seating, Tables, Arms

- Specify model descriptions for seats and tables.
- Specify number of units (seats and tables) and shape.
- Specify support style and powdercoat color for metal.
- Specify number and location of arms per run.

To Specify Litter Receptacles

- Specify side or top opening, size and optional ash pan for side opening.
- Specify powdercoat color.

Visit landscapeforms.com for more information. Specifications are subject to change without notice. Landscape Forms supports the Landscape Architecture Foundation at the Second Century level.
©2021 Landscape Forms, Inc. Printed in U.S.A.