

LEO Area Light

landscapeforms®

Product Data Sheet | LE330 & LE350



LEO area lights are at home in more places. LEO's multiple distributions and outputs address both visual comfort and performance, with configurable options that let landscape architects, lighting designers, and electrical engineers focus on what's important for their project, whether it is an improved visual experience for intimate pedestrian-scale settings or lumen outputs and pole spacing for cost-driven goals. LEO's simple, understated design fits a variety of site designs and architectural styles, and its 19"-diameter housing strikes an aesthetic balance for varying pole heights and spacing.

LEO is Buy America Compliant and International Dark-Sky Approved.

General Description

- Single, double, or staggered configurations
- Offered in 4 standard pole heights (12', 16', 20', and 25')
- Simple clamping mechanism mounts to 4", 5", and 6" diameter poles
- Optional ANSI136.41 7-pin twist lock receptacle
- Optional photo/motion sensor
- Mounting template and anchor hardware included
- Cast aluminum luminaire ships prewired and fully assembled
- Zero up-light, International Dark-Sky approved
- UL Listed, suitable for wet locations

Electrical

Surge protected 100V-277V 50/60 Hz, dimmable Class 2 LED driver mounted within cast aluminum driver compartment. LED cartridge with weatherproof quick-disconnect provides ease of installation and serviceability. LEO ships prewired.

Housing

Luminaire components are cast aluminum. Acrylic lens seals to the LED cartridge housing. Luminaire mounts to 4", 5", and 6" diameter poles with a simple clamping mechanism and is secured with four screws. Driver compartment cover is secured by two screws on top of the luminaire. All hardware is magni-coated.

LEO Area Light

Light Source: Nichia LEDs

Color Temperature: 3000K, 3500K, 4000K

CRI: 80 min

Optics: PMMA

Lens: Clear or Frosted Acrylic

Distributions



TII



TIII



TIV

LEO Area Light

landscapeforms®

Product Data Sheet | LE330 & LE350



Pole Description

Poles are available in 4", 5", and 6" in diameter and are manufactured from seamless 6061 aluminum tubing and heat treated to produce a T6 temper. Wall thickness varies from 0.125" to 0.156" depending on mounting height and number of luminaires. Flush mounted hand hole cover includes two magni-coated fasteners. Base options included a two-piece cast aluminum cover or cast aluminum nut covers.

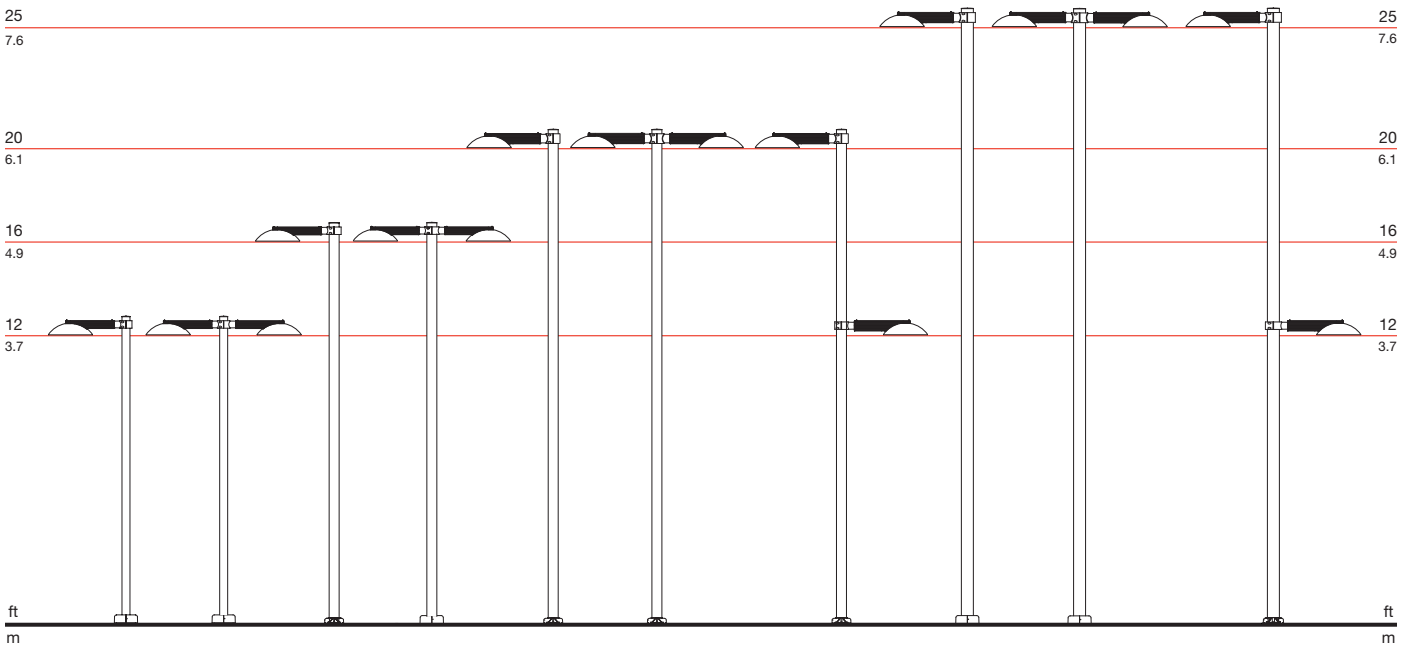

LEO Area Light

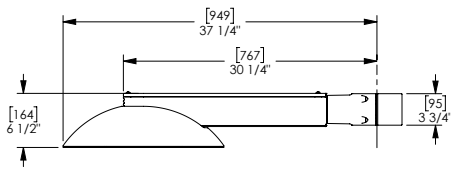

Weight: 40 lbs

EPA: 1.14 ft²

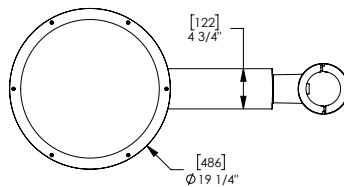

Bracket

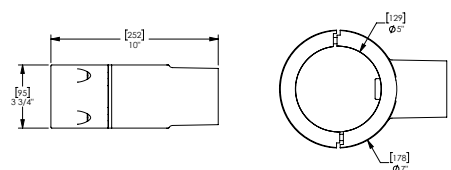

LEO Area Light

landscapeforms®

Product Data Sheet | LE330 & LE350



Model	Distribution Type	Drive Current	Lumens	Watts	Efficacy	BUG Rating
LE330-T2-25F	Type II	250mA	2929	24	122	B1-U0-G1
LE330-T2-37F	Type II	375mA	4245	37	115	B1-U0-G1
LE330-T3-25F	Type III	250mA	2819	24	117	B1-U0-G1
LE330-T3-37F	Type III	375mA	4085	37	110	B1-U0-G1
LE330-T4-25F	Type IV	250mA	2787	24	116	B1-U0-G1
LE330-T4-37F	Type IV	375mA	4039	37	109	B1-U0-G1
LE350-T2-34F	Type II	340mA	6259	55	114	B2-U0-G2
LE350-T2-46F	Type II	460mA	8119	73	113	B2-U0-G2
LE350-T3-34F	Type III	340mA	6024	55	110	B1-U0-G1
LE350-T3-46F	Type III	460mA	7814	73	107	B2-U0-G2
LE350-T4-34F	Type IV	340mA	5956	55	108	B2-U0-G2
LE350-T4-46F	Type IV	460mA	7726	73	106	B2-U0-G2

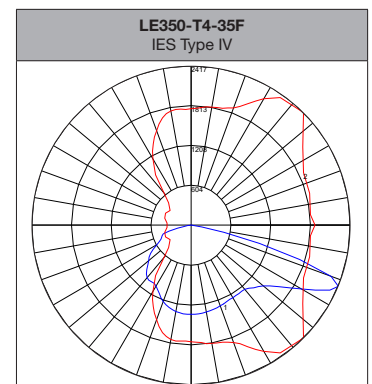
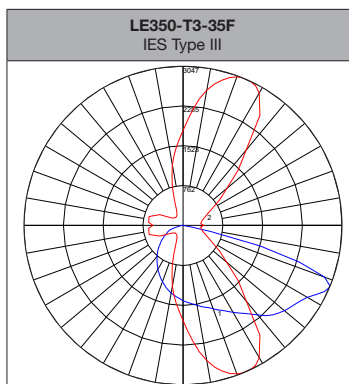
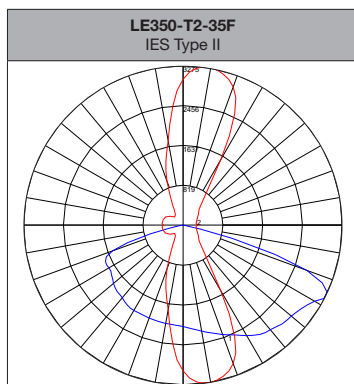
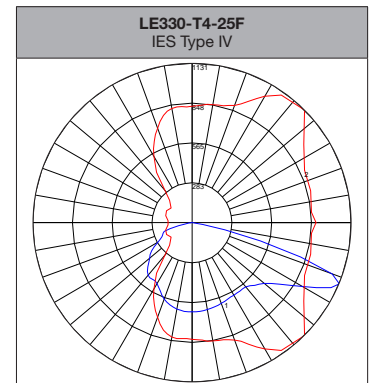
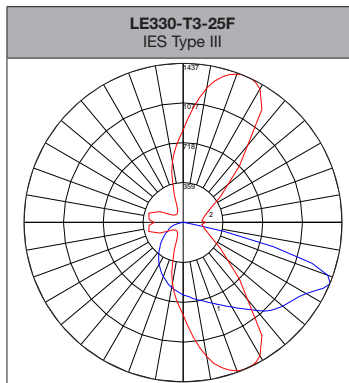
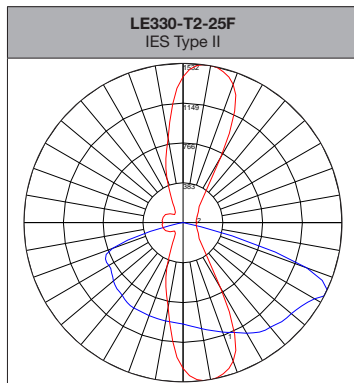

LEO Area Light

landscapeforms®

Product Data Sheet | LE330 & LE350



Photo/Motion Sensor

- Fully adjustable high and low dimmed light levels; optional to dawn control
- Rated for extreme temperatures and up to 200,000 on/off cycles
- Hold off setpoint with automatic calibration option for convenience and added energy savings
- Adjustable via handheld wireless configuration tool
- IP66 rated for wet and outdoor locations
- Adjustable time delay and cut off delay

Click [here](#) to view the technical data sheet for the Wattstopper® FSP-211 photo/motion sensor.

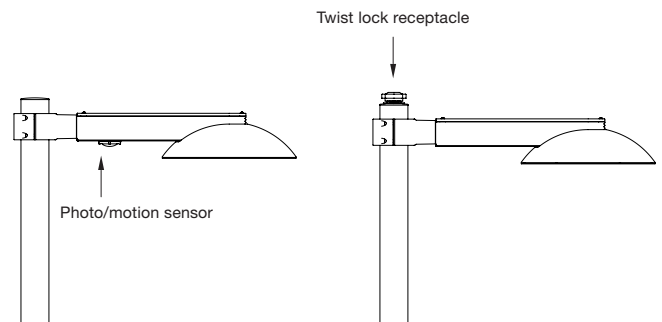

Finish

Pangard II®, offered exclusively by Landscape Forms, is a 19 step program of cleaning, priming, and powdercoating that resists rusting, chipping, peeling and fading to produce the finest metal finish available for site furniture and outdoor lighting. In addition, Pangard II® contains no heavy metals and is free of Hazardous Air Pollutants.

Product Modifications

Don't see what you are looking for? Our goal is to partner with you as the designer to manufacture solutions needed for the space you are creating. We offer the option to modify our standard product to meet certain design specifications or needs. Contact your local Landscape Forms representative to learn more about these offerings.

Product Specifications

Ready to place an order or receive a quote for your project? Reference the LEO Area Light specification sheet available [here](#).

Warranty

LED lighting products are warranted for six years.

Other

UL Listed, RoHS Compliant, Dark-Sky Approved



Designed by John Rizzi in collaboration with Clanton & Associates

[Click here](#) for patent information related to this product.

Visit our website [landscapeforms.com](#) for more information.

Specifications are subject to change without notice. Landscape Forms supports the Landscape Architecture Foundation at the Second Century level. ©2020 Landscape Forms, Inc. Printed in U.S.A.