



landscapeforms®

Bancal

Designed to inspire joy, every day.

The simplicity and sincerity of Bancal benches and picnic tables, designed by distinguished duo Julià Espinàs and Olga Tarrasó for Urbidermis Santa & Cole, celebrates the importance of everyday outdoor experiences. Composed of folded steel understructures that anchor slatted Ipe wood tabletops, bench seats and backs, the furnishings are robust in form and function to serve the outdoor settings essential to people's comfort and enjoyment.





Bancal benches are scalable and modular, perfectly suited for creating precise runs along sidewalks, throughout pedestrian promenades, and in public meeting areas. They can also be alternated, offset, or aligned with their backrests to create thoughtful, site-specific installations that reinforce social wellbeing.















Complementing the benches, Bancal picnic tables are similarly minimal in design and invite groups or individuals to dine, work, or socialize. Throughout streetscapes, public parks, campuses, and hospitality destinations, Bancal benches and picnic tables utilize their purity of design and quality of materials and construction to ensure installations are virtually maintenance free and can withstand weather and wear with aplomb.

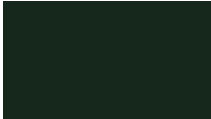

Materials

Vivid Series - Powdercoated Metal (Fine Texture)

						
Clay	Lemon	Mango	Loll Sunset Orange	Chili	Loll Apple Red	Loll Leaf Green
						
Moss	Forest	Loll Navy Blue				

Neutral Series - Powdercoated Metal

						
Silver Metallic	Mercury Metallic	Steel Metallic	Bronze Metallic	Titanium Metallic	Gloss Black	Gloss White

Materials (cont.)

Architectural Series - Powdercoated Metal (Fine Texture)



Fog

Obsidian

Matte Black

Terra

Nutmeg

Onyx

Sage



Blue Ash

Dusk

Woodgrains (Exterior, No Finish)

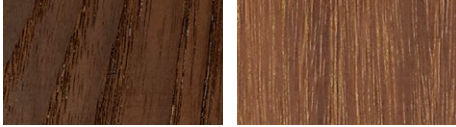

Domestically Sourced
Thermally Modified Ash

Ipe (P)

Statement of Line

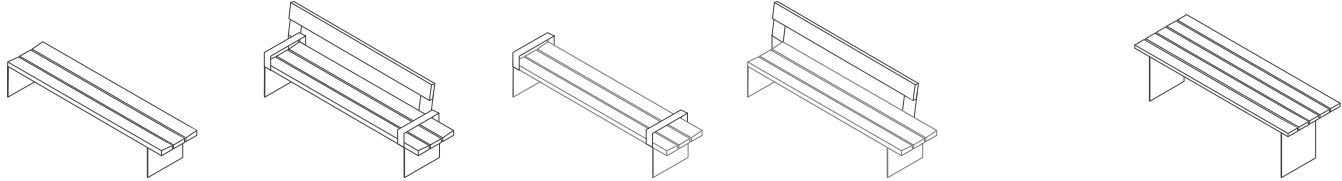

Bench

Table

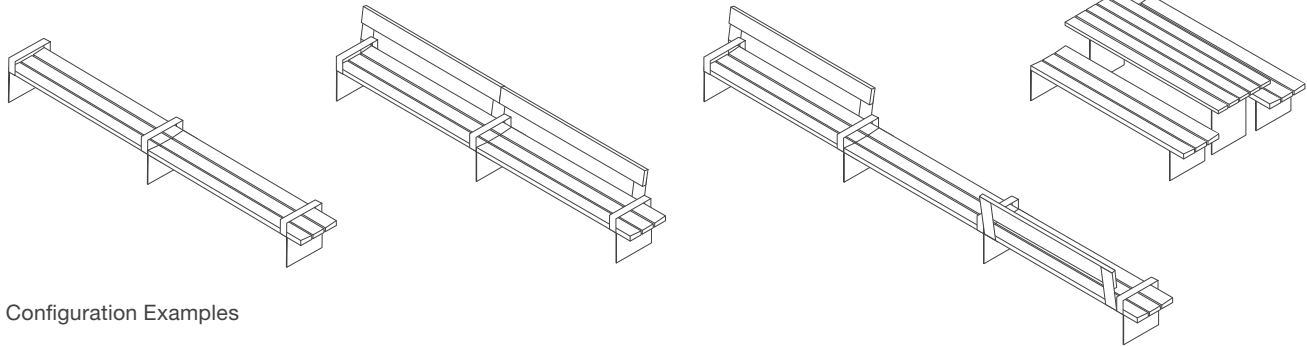

Configuration Examples



landscapeforms®

Bancal