

Moment

Specification Sheet | DZ 500/600



Moment’s design is rooted in the elemental interplay of straight lines, perfect circles, and conical shapes. The minimalist profile of Moment finds expression in a sculptural design that is both artful and practical, presenting a streamlined and unadorned silhouette that effortlessly complements any public space environment.

Beneath the sleek exterior, Moment incorporates the perfect balance of performance and visual experience options, including a wide selection of roadway and accent distribution types, and up to 10,000lm delivered. Accent distribution types feature tilt adjustability (lockable in 10deg increments), infinite rotation, a 3” recessed light engine and an optional hexcell louvre.

Moment is proudly made in Michigan and International Dark-Sky Approved.

Housing & Materials

Cast Aluminum and cast Stainless Steel construction. Factory sealed and replaceable light engine cartridge with UV stable, impact modified clear or diffused acrylic lens. With a ‘fastener free’ look, all hardware is magni-coated for optimum corrosion and ‘anti-seize’ protection. Assembly is IP66 rated.

Electrical

Surge protected 120V - 277V 50/60Hz electronic driver located internal to luminaire, 0-10V dimmable.

Light Engine

Moment features a replaceable LED cartridge with die-cast aluminum heatsink, high power LEDs on a RoHS compliant circuit board with secondary optics in either Roadway or Accent distribution types. Accent distributions feature a 3” recessed depth, and optional hexcell louvre. All configurations are available in 2700K, 3000K, and 4000K. >80CRI across all available color temperatures. Luminaires meet or exceed TM21 L70: >60,000 hrs.

Distributions

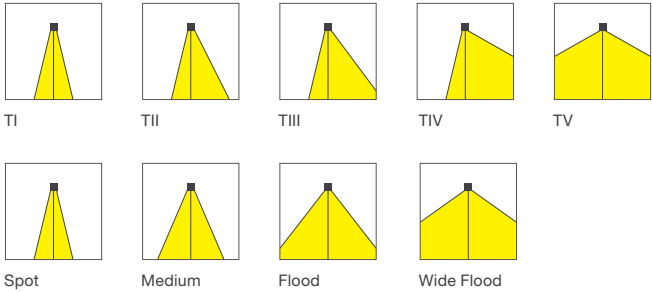

Warranty

Luminaires are warranted for six years.

Certification

UL Listed for Wet Location, International Dark Sky Approved, RoHS Compliant, cUL



Designed by Yonoh Creative Studio

[Click here](#) for patent information related to this product.

Specification

Luminaire _____

Luminaire Configurations – Roadway/Area Optic – 500 Series

Product	LED Configuration	Drive Current	Color Temp	Distribution	Lens	Powdercoat
DZ501 <i>(Single Luminaire)</i>	30 <i>(30 LED)</i>	SO <i>(Standard Output)</i>	27K <i>(2700K)</i>	T1 <i>(Type I)</i>	CLR <i>(Clear)</i>	See powdercoat color options on the Material / Colors Sheet.
	50 <i>(50 LED)</i>	HO <i>(High Output)</i>	30K <i>(3000K)</i>	T2 <i>(Type II)</i>		
				40K <i>(4000K)</i>	T3 <i>(Type III)</i>	
				T4 <i>(Type IV)</i>		
				T5 <i>(Type V)</i>		

Example: DZ501 – 50 – HO – 30K – TIII – CLR – MBK

Luminaire Configurations – Accent Optic – 600 Series

Product	LED Configuration	Drive Current	Color Temp	Distribution	Louvre	Lens	Powdercoat
DZ601 <i>(Single Luminaire)</i>	30 <i>(30 LED)</i>	SO <i>(Standard Output)</i>	27K <i>(2700K)</i>	SP <i>(Spot (20°))</i>	LV1 <i>(Louvre-With)</i>	CLR <i>(Clear)</i>	See powdercoat color options on the Material / Colors Sheet.
	50 <i>(50 LED)</i>	HO <i>(High Output)</i>	30K <i>(3000K)</i>	ME <i>(Medium (25°))</i>			
				40K <i>(4000K)</i>	FL <i>(Flood (45°))</i>	NLV <i>(Louvre-Without)</i>	
				WF <i>(Wide Flood (75°))</i>			

Example: DZ601 – 50 – HO – 30K – ME – LV1 – CLR – MBK

Moment

Specification Sheet | DZ 500/600

500 & 600 Series Luminaire Dimensions, Weights and EPA's

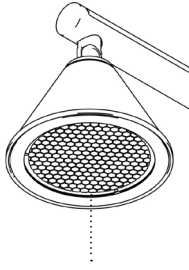
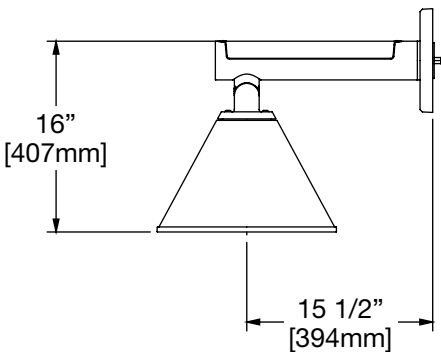
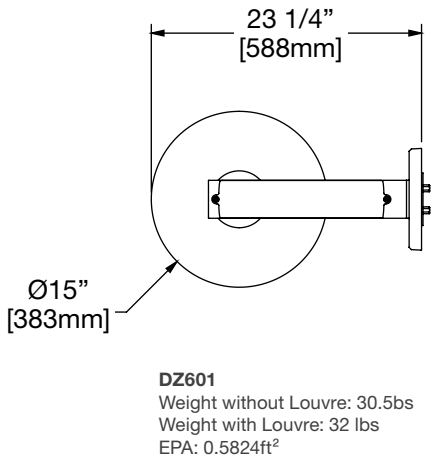
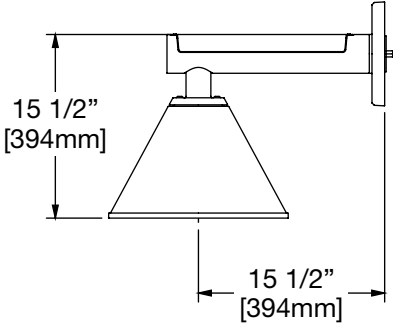
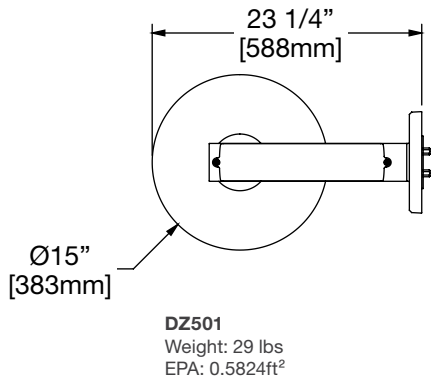

Hexcell Louvre
 For use with accent optics only.

Mounting

Cast stainless steel mounting plate attaches to wall, requires separate anchor points from junction box. Luminaire arm attaches to mounting plate via 3 bolts internal to the driver housing/arm. All hardware made from stainless steel.

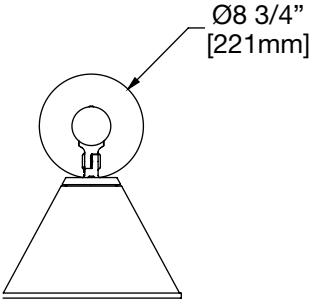

Luminaire Performance Data – Roadway/Area Optic 500/600 Series

LED Quantity	Drive Current	Lens	Distribution Type	Lumen Output	Efficacy	Input Power (W)	BUG Rating
30	SO	Clear	T1	2553	128	20	B1-U0-G1
			T2	2550	128	20	B1-U0-G1
			T3	2406	120	20	B1-U0-G1
			T4	2275	114	20	B1-U0-G1
			T5	2493	125	20	B1-U0-G0
		Frosted	T1	2291	115	20	B1-U0-G1
			T2	2288	114	20	B1-U0-G1
			T3	2169	108	20	B1-U0-G1
			T4	2005	100	20	B1-U0-G1
			T5	2210	111	20	B1-U0-G1
	HO	Clear	T1	5121	116	44	B2-U0-G2
			T2	5116	116	44	B1-U0-G1
			T3	4827	110	44	B1-U0-G1
			T4	4565	104	44	B2-U0-G2
			T5	5002	114	44	B2-U0-G1
Frosted		T1	4605	105	44	B2-U0-G1	
		T2	4599	105	44	B1-U0-G1	
		T3	4352	99	44	B1-U0-G1	
		T4	4029	92	44	B1-U0-G1	
		T5	4442	101	44	B2-U0-G1	
50	SO	Clear	T1	7501	123	61	B2-U0-G2
			T2	7493	123	61	B2-U0-G2
			T3	7071	116	61	B2-U0-G2
			T4	6686	110	61	B2-U0-G2
			T5	7326	120	61	B3-U0-G1
		Frosted	T1	6734	110	61	B2-U0-G2
			T2	6724	110	61	B2-U0-G1
			T3	6364	104	61	B1-U0-G1
			T4	5892	97	61	B2-U0-G1
			T5	6494	106	61	B2-U0-G1
	HO	Clear	T1	9747	117	83	B3-U0-G3
			T2	9737	117	83	B2-U0-G2
			T3	9188	111	83	B2-U0-G2
			T4	8688	105	83	B2-U0-G2
			T5	9520	115	83	B3-U0-G1
Frosted	T1	8751	105	83	B3-U0-G2		
	T2	8738	105	83	B2-U0-G2		
	T3	8270	100	83	B2-U0-G1		
	T4	7656	92	83	B2-U0-G1		
	T5	8439	102	83	B3-U0-G1		

Luminaire Performance Data – Accent Optic 500/600 Series

LED Quantity	Drive Current	Lens	Beam Angle	Lumen Output (lm)	Efficacy (lm/W)	Input Power (W)	Peak Intensity (cd)
30	SO	Clear	SP	2477	118	21	13001
			SP+LV1	1352	64	21	10845
			ME	2351	112	21	8755
			FL	2349	112	21	4599
		WF	2473	118	21	1598	
		Frosted	SP	2429	116	21	8765
			ME	2297	109	21	6194
			FL	2316	110	21	4090
	WF		2268	108	21	1521	
	HO	Clear	SP	4953	113	44	26001
			SP+LV1	2703	61	44	21690
			ME	4701	107	44	17510
			FL	4697	107	44	9225
		WF	4945	112	44	3196	
		Frosted	SP	4861	110	44	17563
			ME	4596	104	44	12411
FL			4629	105	44	8179	
WF	4539		103	44	3047		
50	SO	Clear	SP	7095	114	62	37285
			SP+LV1	3872	62	62	31102
			ME	6734	109	62	25109
			FL	6729	109	62	13645
		WF	7084	114	62	4583	
		Frosted	SP	6957	112	62	25139
			ME	6579	106	62	17763
			FL	6626	107	62	12003
	WF		6496	105	62	4361	
	HO	Clear	SP	9338	113	83	49059
			SP+LV1	5096	61	83	40924
			ME	8863	107	83	33038
			FL	8856	107	83	17730
		WF	9324	112	83	6030	
		Frosted	SP	9157	110	83	33077
			ME	8659	104	83	23373
FL			8721	105	83	15794	
WF	8550		103	83	5738		

Moment

Specification Sheet | DZ 500/600

500 Series- 30 LED SO CLR lens at 12'

Performance light engine @ 3000K

1.0fc 0.5fc 0.2fc

12' Lens Height, Type I

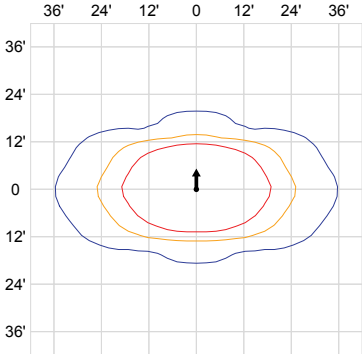

12' Lens Height, Type II

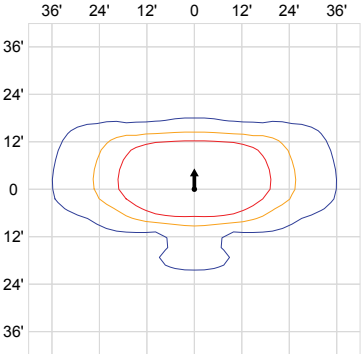

12' Lens Height, Type III

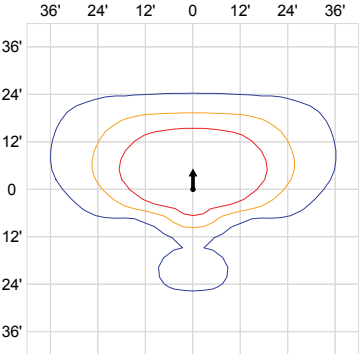

12' Lens Height, Type IV

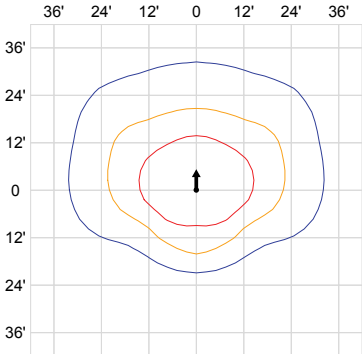

12' Lens Height, Type V

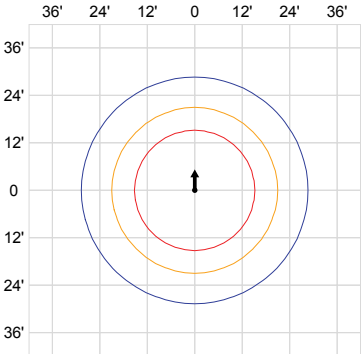

Moment

Specification Sheet | DZ 500/600

500 Series - 30 LED HO CLR lens at 14'

Performance light engine @ 3000K

1.0fc 0.5fc 0.2fc

14' Lens Height, Type I

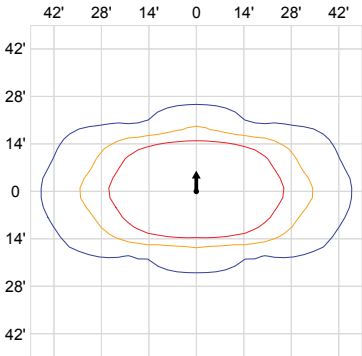

14' Lens Height, Type II

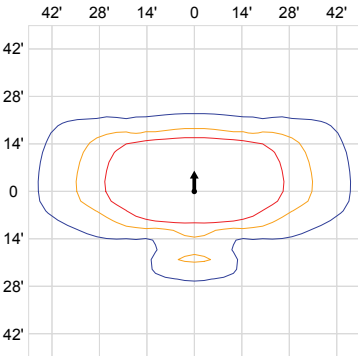

14' Lens Height, Type III

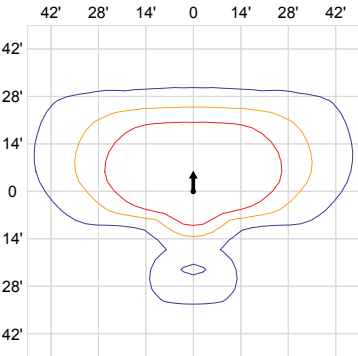

14' Lens Height, Type IV

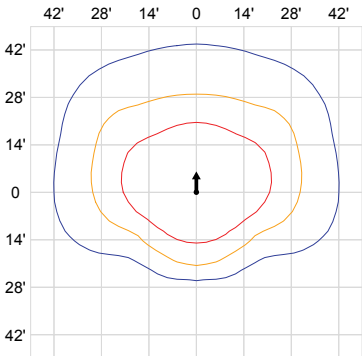

14' Lens Height, Type V

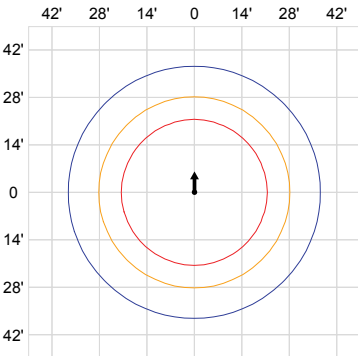

Moment

Specification Sheet | DZ 500/600

500 Series - 50 LED SO CLR lens at 16'

Performance light engine @ 3000K

1.0fc 0.5fc 0.2fc

16' Lens Height, Type I

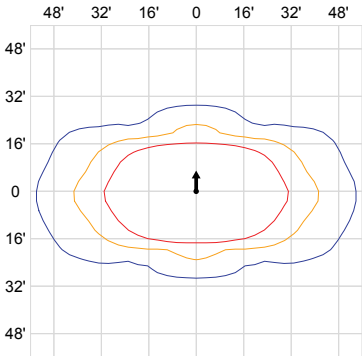

16' Lens Height, Type II

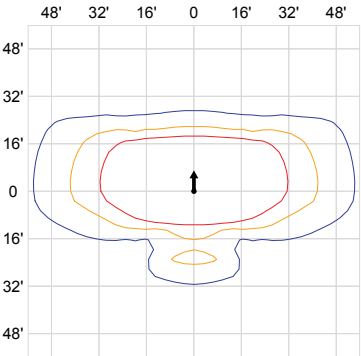

16' Lens Height, Type III

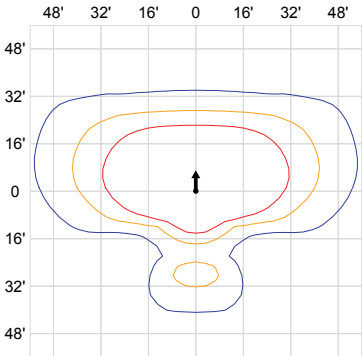

16' Lens Height, Type IV

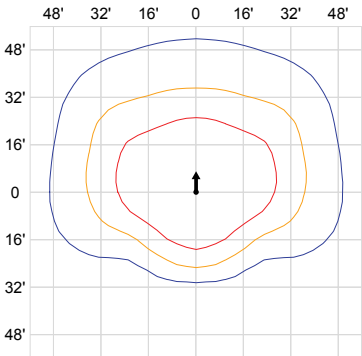

16' Lens Height, Type V

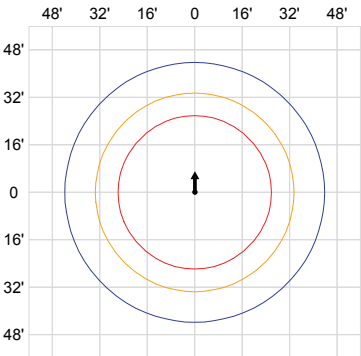

Moment

Specification Sheet | DZ 500/600

500 Series - 50 LED HO CLR lens at 20'

Performance light engine @ 3000K

1.0fc 0.5fc 0.2fc

20' Lens Height, Type I

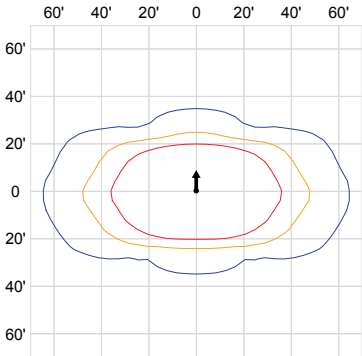

20' Lens Height, Type II

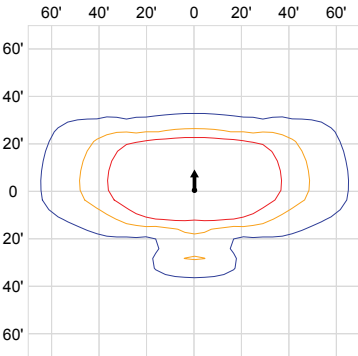

20' Lens Height, Type III

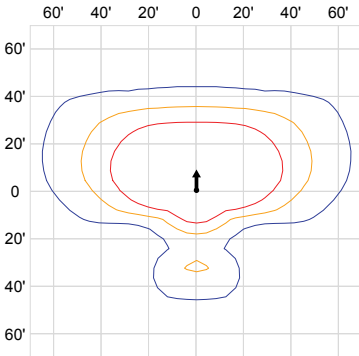

20' Lens Height, Type IV

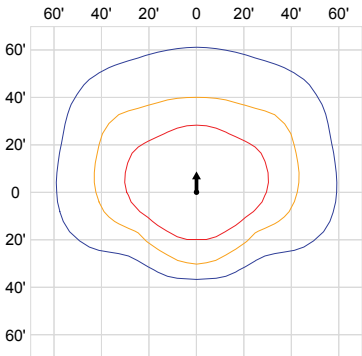

20' Lens Height, Type V

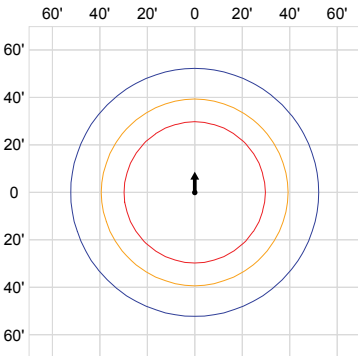

Moment

Specification Sheet | DZ 500/600

500 Series - 50 LED HO CLR lens at 25'

Performance light engine @ 3000K

1.0fc 0.5fc 0.2fc

25' Lens Height, Type I

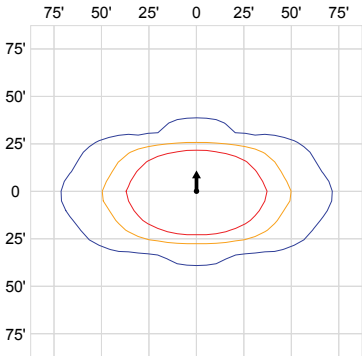

25' Lens Height, Type II

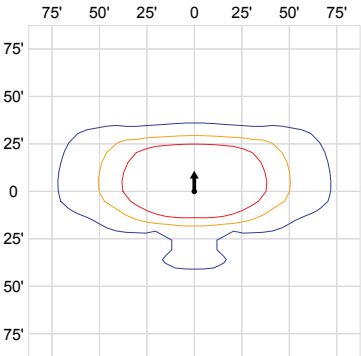

25' Lens Height, Type III

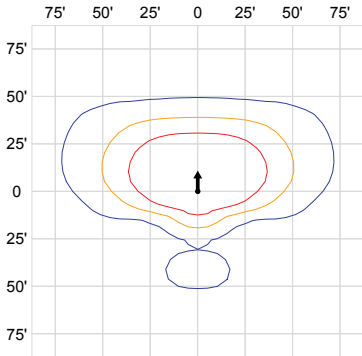

25' Lens Height, Type IV

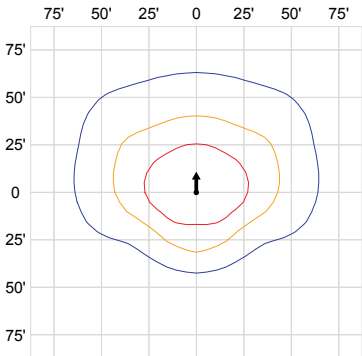

25' Lens Height, Type V

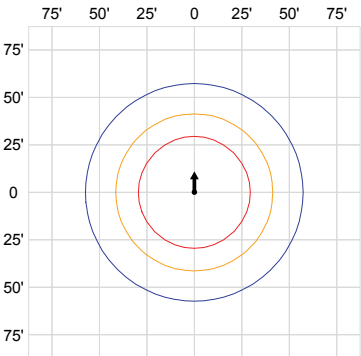

Moment

Specification Sheet | DZ 500/600

600 - 30 LED SO CLR lens

Performance light engine @ 3000K

■ 10% max CD ■ 50% max CD

Spot Optic 20° (SP)

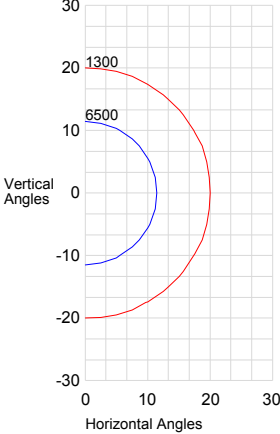
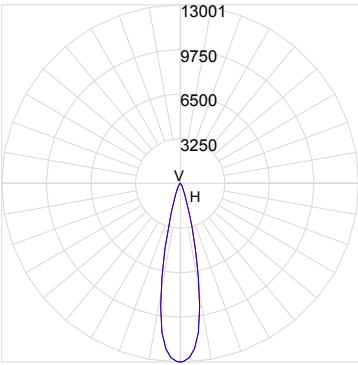

Medium 25° (ME)

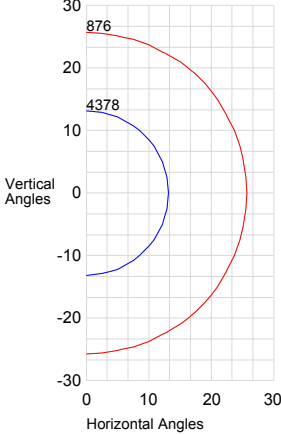
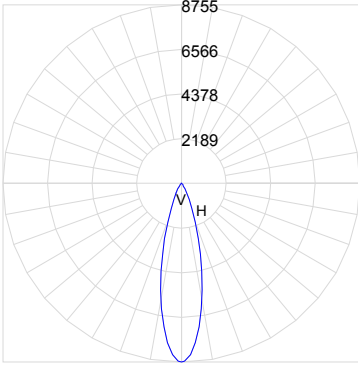

Flood 45° (FL)

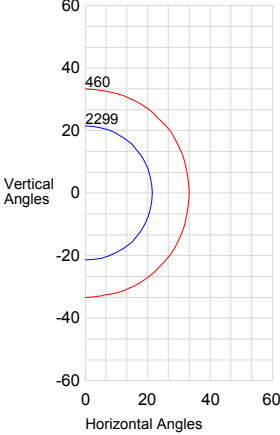
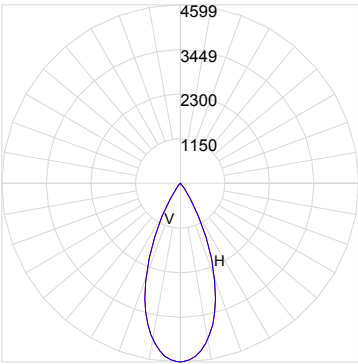

Wide Flood 75° (WF)

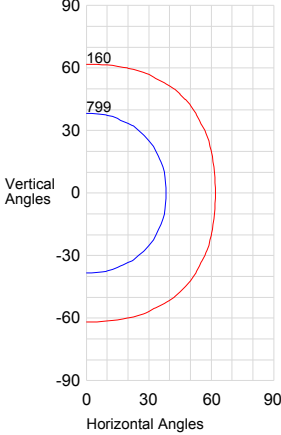
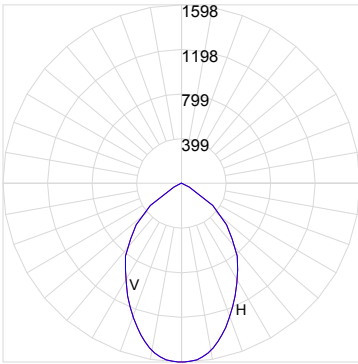

Moment

Specification Sheet | DZ 500/600

600 - 30 LED HO CLR lens

Performance light engine @ 3000K

■ 10% max CD ■ 50% max CD

Spot Optic 20° (SP)

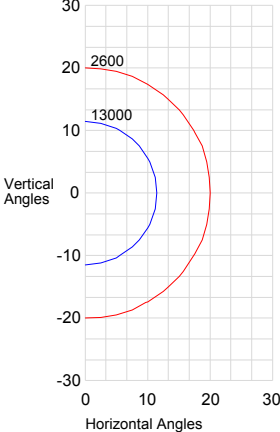
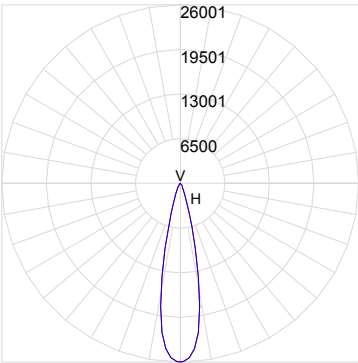

Medium 25° (Medium)

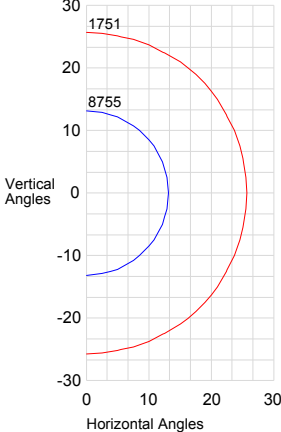
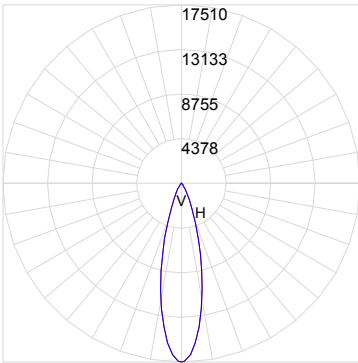

Flood 45° (FL)

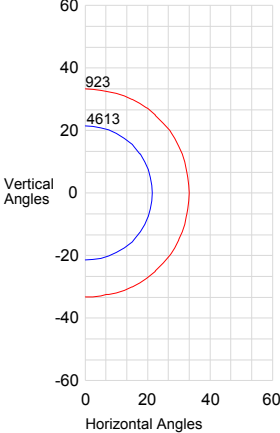
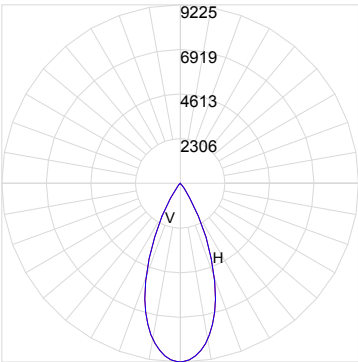

Wide Flood 75° (WF)

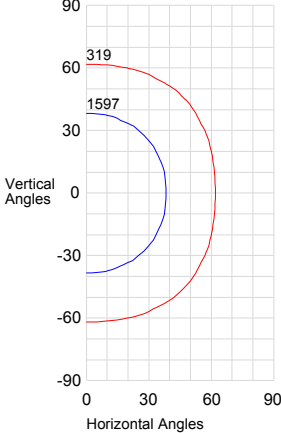
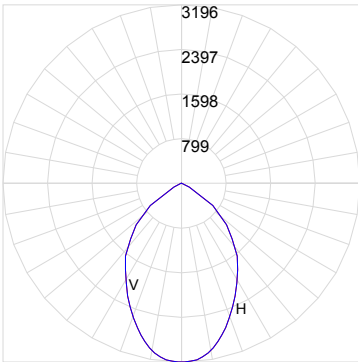

Moment

Specification Sheet | DZ 500/600

600 - 50 LED SO CLR lens

Performance light engine @ 3000K

10% max CD 50% max CD

Spot Optic 20° (SP)

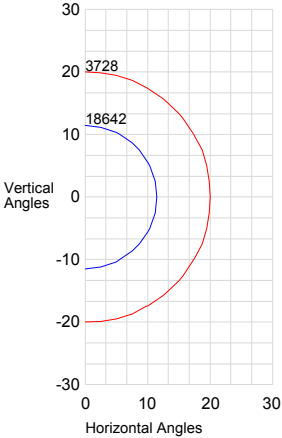
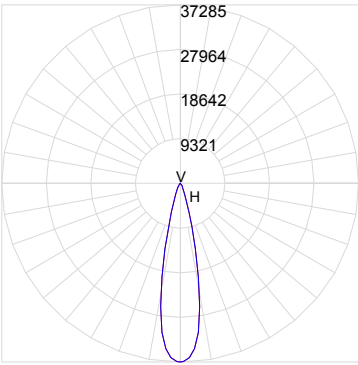

Medium 25° (ME)

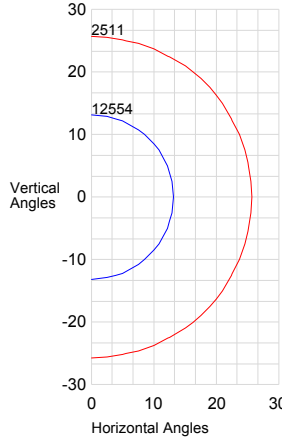
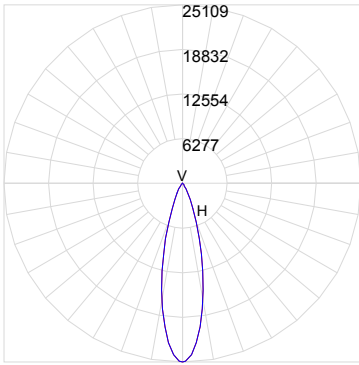

Flood 45° (FL)

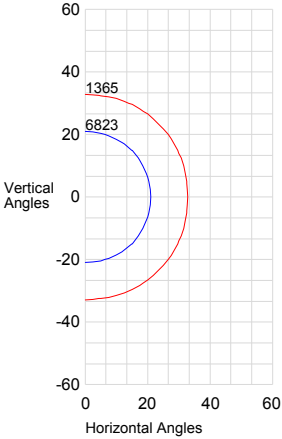
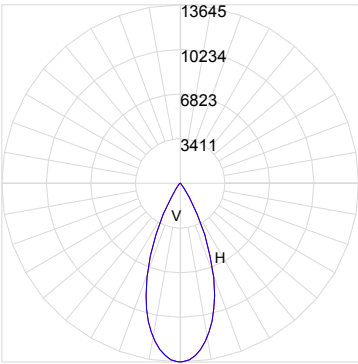

Wide Flood 75° (WF)

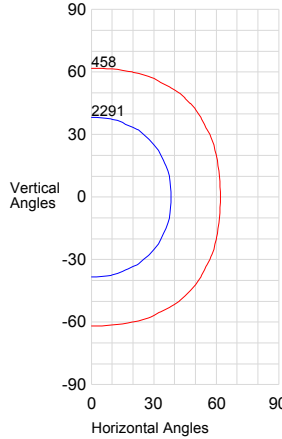
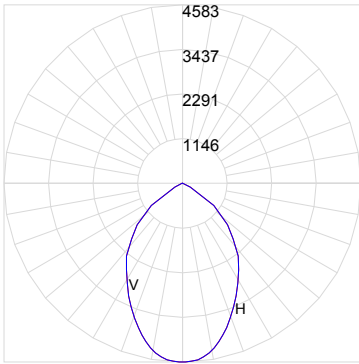

Moment

Specification Sheet | DZ 500/600

600 Series- 50 LED HO CLR lens

■ 10% max CD ■ 50% max CD

Performance light engine @ 3000K

Spot Optic 20° (SP)

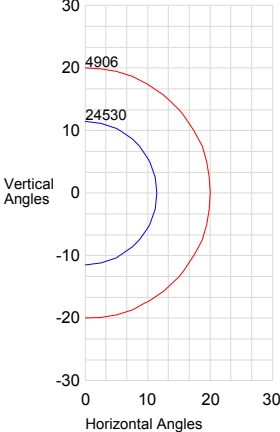
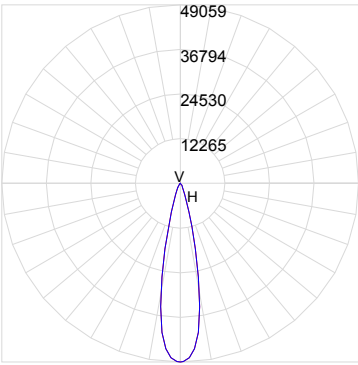

Medium 25° (ME)

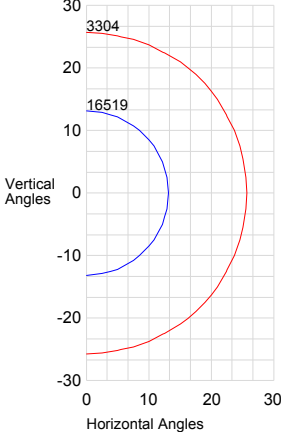
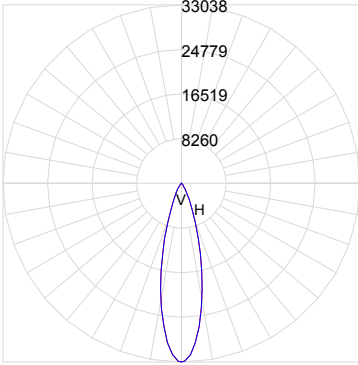

Flood 45° (FL)

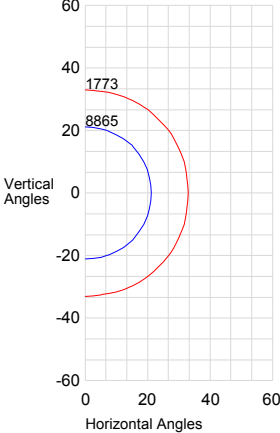
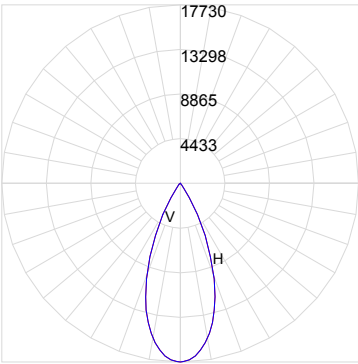

Wide Flood 75° (WF)

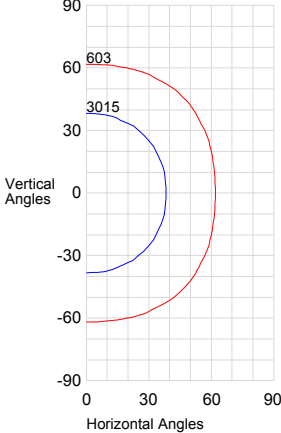
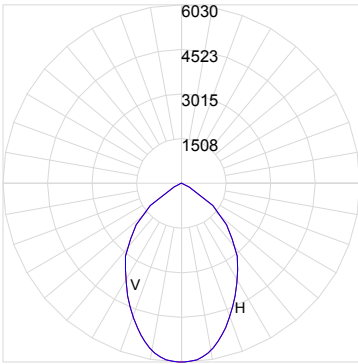

Architectural Series - Powdercoated Metal* (Fine Texture)

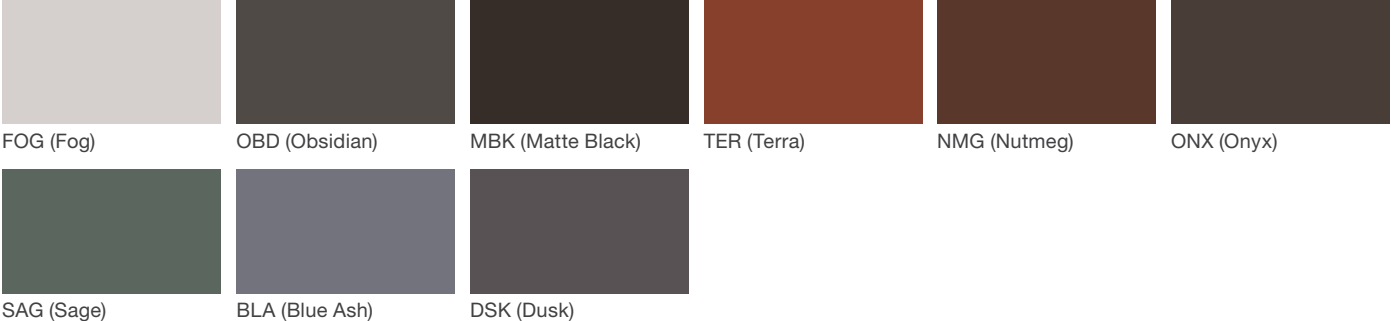

Neutral Series - Powdercoated Metal*



Vivid Series - Powdercoated Metal* (Fine Texture)

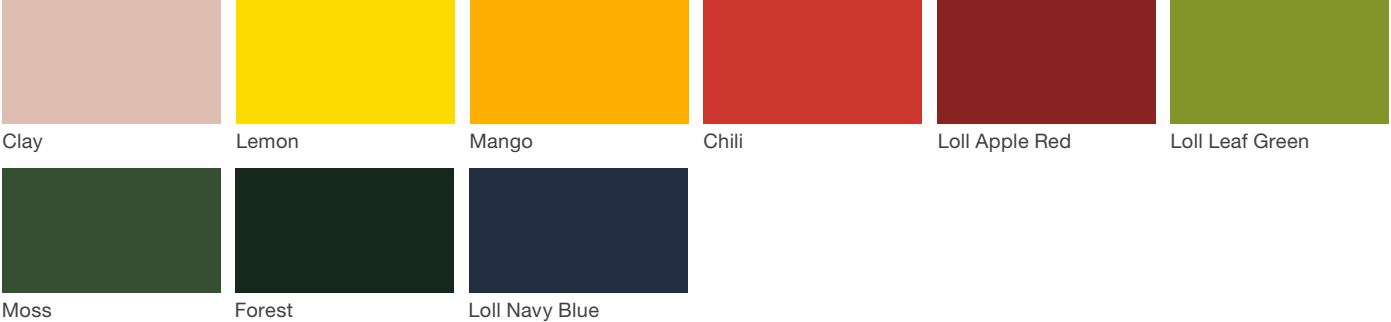

Powdercoated Metal

Powdercoated Metal Pangard II® Polyester Powdercoat is a hard, yet flexible, finish that resists rusting, chipping, peeling and fading. In addition to colors shown, a wide selection of optional and custom colors may be specified for an upcharge.

* All colors and patterns shown are approximate and may vary from sample and final.

Visit landscapeforms.com for more information.

Specifications are subject to change without notice.

©2025 Landscape Forms, Inc. Printed in U.S.A.

landscapeforms.com | specify@landscapeforms.com